



HAL
open science

Karyotype diversity suggests that *Laonastes aenigmamus* (Laotian rock rat) (Rodentia, Diatomyidae) is a multi-specific genus

Florence Richard, Bounneuang Douangboupha, Kham Keovichit, Jean-Pierre Hugot, Bernard Dutrillaux

► To cite this version:

Florence Richard, Bounneuang Douangboupha, Kham Keovichit, Jean-Pierre Hugot, Bernard Dutrillaux. Karyotype diversity suggests that *Laonastes aenigmamus* (Laotian rock rat) (Rodentia, Diatomyidae) is a multi-specific genus. *Chromosome Research*, 2016, 24 (3), pp.379-392. 10.1007/s10577-016-9527-7 . mnhn-02365747

HAL Id: mnhn-02365747

<https://mnhn.hal.science/mnhn-02365747>

Submitted on 15 Nov 2019

HAL is a multi-disciplinary open access archive for the deposit and dissemination of scientific research documents, whether they are published or not. The documents may come from teaching and research institutions in France or abroad, or from public or private research centers.

L'archive ouverte pluridisciplinaire **HAL**, est destinée au dépôt et à la diffusion de documents scientifiques de niveau recherche, publiés ou non, émanant des établissements d'enseignement et de recherche français ou étrangers, des laboratoires publics ou privés.

Karyotype diversity suggests that *Laonastes aenigmamus* (Laotian rock rat) (Rodentia, Diatomyidae) is a multi-specific genus

Florence Richard, Michèle Gerbault-Seureau, Bounneuang Douangboupha, Kham Keovichit, Jean-Pierre Hugot, Bernard Dutrillaux

► **To cite this version:**

Florence Richard, Michèle Gerbault-Seureau, Bounneuang Douangboupha, Kham Keovichit, Jean-Pierre Hugot, et al.. Karyotype diversity suggests that *Laonastes aenigmamus* (Laotian rock rat) (Rodentia, Diatomyidae) is a multi-specific genus. *Chromosome Research*, Springer Verlag, 2016, 24 (3), pp.379-392. 10.1007/s10577-016-9527-7 . mnhn-02365747

HAL Id: mnhn-02365747

<https://hal-mnhn.archives-ouvertes.fr/mnhn-02365747>

Submitted on 15 Nov 2019

HAL is a multi-disciplinary open access archive for the deposit and dissemination of scientific research documents, whether they are published or not. The documents may come from teaching and research institutions in France or abroad, or from public or private research centers.

L'archive ouverte pluridisciplinaire **HAL**, est destinée au dépôt et à la diffusion de documents scientifiques de niveau recherche, publiés ou non, émanant des établissements d'enseignement et de recherche français ou étrangers, des laboratoires publics ou privés.

Karyotype diversity suggests that *Laonastes aenigmamus* (Laotian rock rat) (Rodentia, Diatomyidae) is a multi-specific genus

Florence Richard · Michèle Gerbault-Seureau ·
Bounneuang Douangboupha · Kham Keovichit ·
Jean-Pierre Hugot · Bernard Dutrillaux

Received: 1 February 2016 / Revised: 21 April 2016 / Accepted: 25 April 2016

Abstract *Laonastes aenigmamus* (Khanyou) is a recently described rodent species living in geographically separated limestone formations of the Khammuan Province in Lao PDR. Chromosomes of 21 specimens of

Responsible Editor: Fengtang Yang.

This paper was prepared after the tragic death of Florence Richard, the day of her 50th anniversary. Florence practiced cytogenetics during all her professional life. She started working on cancer, at the Curie Institute in Paris, where she got her PhD. In addition to her teaching activities, she became expert in fluorescent in situ hybridization in early 1990s and participated to the publication of a book on molecular cytogenetics, with M. Muleris, F. Apiou, and B. Dutrillaux. She rapidly applied her competences in comparative cytogenetics and moved to the Muséum National d'Histoire Naturelle of Paris in 2003. A large part of her comparative cytogenetic papers were published in Chromosome Research and Cytogenetics and Genome Research. Her last research activities, focused on *Laonastes aenigmamus*, are reported in the above paper. Florence Richard will remain as a very sympathetic person, with multiple human interactions, in the domains of both teaching, at the University of Versailles-Saint Quentin and research at the Muséum National d'Histoire Naturelle.

F. Richard · M. Gerbault-Seureau · J.-P. Hugot ·
B. Dutrillaux (✉)
Institut de Systématique, Evolution, Biodiversité ISyEB-UMR
7205 CNRS MNHN UPMC EPHE, Muséum National d'Histoire
Naturelle, Sorbonne Universités 57, rue Cuvier, CP39,
75005 Paris, France
e-mail: mailto:bdutrill@mnhn.fr

B. Dutrillaux
e-mail: bdutrill@mnhn.fr

B. Douangboupha · K. Keovichit
National Agriculture and Forestry Research Institute (NAFRI),
Vientiane, Lao People's Democratic Republic

L. aenigmamus were studied using chromosome banding as well as fluorescent in situ hybridization (FISH) techniques using human painting, telomere repeats, and 28S rDNA probes. Four different karyotypes were established. Study with human chromosome paints and FISH revealed that four large chromosomes were formed by multiple common tandem fusions, with persistence of some interstitial telomeres. The rearrangements separating the different karyotypes (I to IV) were also reconstructed. Various combinations of Robertsonian translocations or tandem fusions involving the same chromosomes differentiate these karyotypes. These rearrangements create a strong gametic barrier, which isolates specimens with karyotype II from the others. C-banding and FISH with telomere repeats also exhibit large and systematized differences between karyotype II and others. These data indicate an ancient reproductive separation and suggest that *Laonastes* is not a mono-specific genus.

Keywords *Laonastes aenigmamus* · Chromosomes ·
Rearrangements · Gametic barrier

Abbreviations

FISH	Fluorescent in situ hybridization
KCl	Potassium chloride
HSA	Homo sapiens
MNHN	Muséum National d'Histoire Naturelle
DMSO	Dimethyl sulfoxide
Karyo	Karyotype
P	Painting probe

Introduction

The fauna of the karstic region, which spreads over a large part of the Lao PDR between the Mekong River and the Vietnam border, remained for long largely unknown for the scientific community. In the Khammouane region, there is a recently described endemic species, *Laonastes aenigmamus* (Laotian rock rat or Khanyou) (Jenkins et al. 2005). It was morphologically classified among the Diatomyidae, a rodent family, which was thought to have been extinct about 11 million years ago. *L. aenigmamus* occurs in karstic mounts, which are the remains of a large calcic block, which covered the whole region about 20 million years ago, and was progressively fragmented in limestone outcrops by erosion. They are now separated from each other by cultured areas and constitute insulated biotopes favoring the development of a rich endemic biodiversity. Molecular studies of *L. aenigmamus* led to two main conclusions: (1) This species and thus the Diatomyidae are phylogenetically close to the Ctenodactylidae family (Huchon et al. 2007) and (2) a large diversity of genotypes, in relation with their geographic distribution, suggests a strong micro-endemism (Nicolas et al. 2012). These last authors identified eight well-supported clades, each belonging to a well-defined area. Here, we report the chromosome data for 21 of the specimens, which were used in the Nicolas et al. (2012) study. Although no morphological differences were noticed, four different karyotypes were observed. Their chromosomes were identified by both chromosome banding and ZOOFISH, which indicated their homologies with human chromosomes. Inter-individual comparisons show that the four largest chromosomes are formed by the tandem fusions of multiple fragments homologous to human chromosomes of which two are involved in different combinations in these large chromosomes. This creates homobrachial heterozygosity susceptible to disturb meiosis and reduce the fertility of the progeny. The conserved synteny, identified by fluorescent in situ hybridization (FISH) of human probes, in the *Laonastes* karyotype are compared with those described in other rodents or reconstructed ancestral karyotypes (Richard et al. 2003; Stanyon et al. 2004; Romanenko et al. 2006; Graphodatsky et al. 2008; Beklemisheva et al. 2011; Sannier et al. 2011). The question of the congruence between the chromosomal and molecular data and the existence of either a single and highly diversified species or a multi-specific genus is discussed.

Material and methods

Our successive missions provided us with 71 specimens of *L. aenigmamus*. Most of them were trapped, but some were simply bought on local food markets. Biopsies (3) or necropsies (68) of muscular tissue were immediately dipped in a transport sterile physiological solution (D-MEN (Gibco) with glutamax (Thermo Fisher Scientific) + fetal calf serum (10 %) supplemented with antibiotics and fungicides (penicillin-streptomycin 40 UI/ml, amphotericin B 2.5 g/ml, gentamycin 100 mg/ml). They were conserved at about 6 °C until return to our laboratory in Paris, where cell cultures were initiated. In spite of the bacterial contamination of most samples, a fibroblast proliferation, sufficient for metaphase harvesting and cytogenetic analyses, was obtained for 21 of the 71 captured specimens (Fig. 1).

Cell cultures, metaphase preparations, and chromosome banding

Tissue fragments were rinsed, and explants were grown at 37 °C in a new sterile physiological solution (D-MEN high with glutamax, added with 10 % fetal calf serum supplemented with antibiotics and fungicides: penicillin-streptomycin 20 UI/ml, amphotericin B, 1.25 g/ml, gentamycin 50 mg/ml). For R-banded (RBG) metaphase preparations, fluorodeoxyuridine (FdU, Sigma, final concentration 0.06 mg/ml) was used to synchronize cultures during the last 18 h. 5'-Bromodeoxyuridine (BrdU, Sigma, final concentration 0.02 mg/ml) was added to reinitiate cell proliferation and for incorporation into late replicating DNA for the last 7–8 h. Colchicine (Sigma, St. Louis, USA) (0.04 mg/ml) was added for the two last hours. Hypotonic shock (fetal calf serum 1 vol./distilled water 5 vol. and KCl, final concentration 0.93 mg/ml) was used for 10 min at 37 °C. Cells were fixed with Carnoy I fixative, spread on cold slides, dried, and stored at –20 °C. RHG, G-banding (GBG), CBG, and AgNOR chromosome banding techniques were also applied on two to six specimens with each karyotype (Dutrillaux and Couturier 1981; Popescu et al. 1998). Metaphases were karyotyped using the Ikaros 3 software (Metasystems, Altusheim, Germany).

For each karyotyped specimen, muscular tissue and cultivated fibroblasts (10–100 million cells) were put in physiological solution (D-MEN with glutamax, added with 10 % fetal calf serum supplemented with

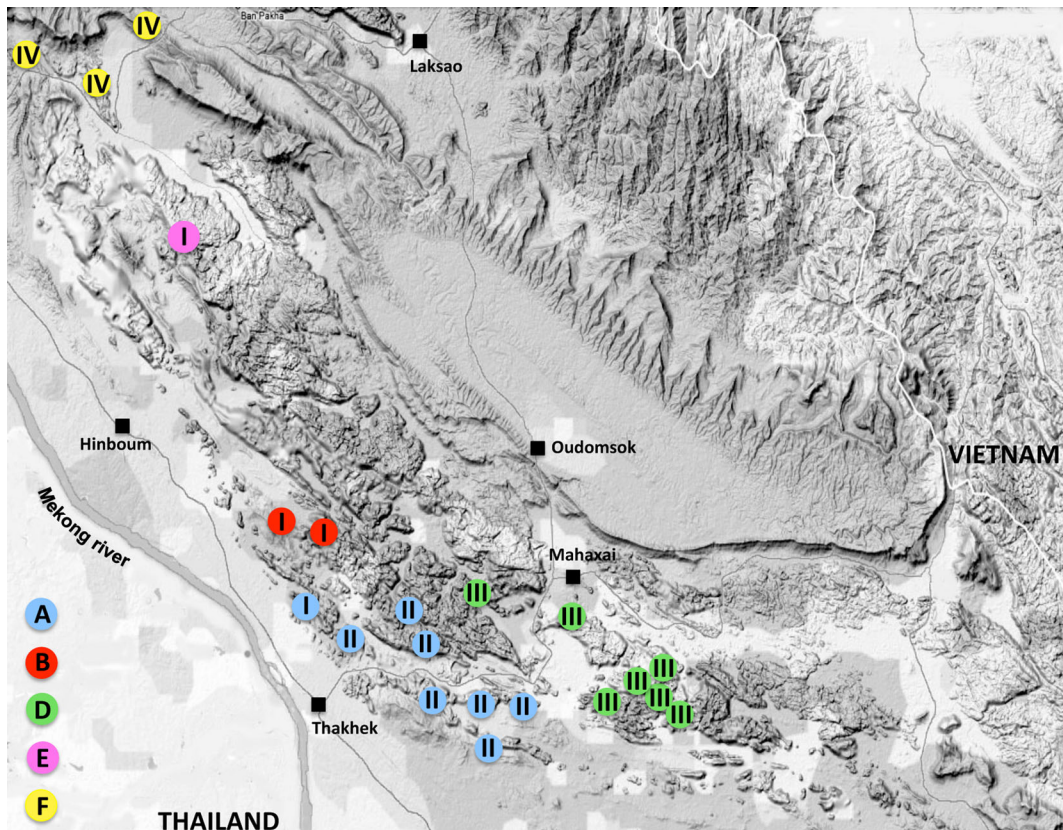

Fig. 1 Map of the Khammuan Region (Lao PDR) with indication of the sampling points. Roman numbers (*I* to *IV*) correspond to the different karyotypes, and *colors* refer to the mtDNA groups (*A* to *F*) defined by Nicolas et al. (2012)

cryoprotector (10 % DMSO (Sigma)) and cryo-conserved in liquid nitrogen. The material was stored in the RBCell (Ressources Biologiques de cellules vivantes: Tissus et cellules cryoconservés de vertébrés) collection, at the Muséum National d'Histoire Naturelle of Paris.

Fluorescent in situ hybridization techniques

In situ hybridization of a ribosomal probe (28S DNA) and whole chromosome painting were performed following Gerbault-Seureau et al. (2004). Human chromosome probes (Homo sapiens (HSA) 1 to 22 and X), supplied by Cambio-Adgenix (France), were used according to the manufacturer's protocol. The 28S probe (kindly prepared by Bernard Malfoy, Institut Curie, Paris) was labeled with biotin-14-dATP (Invitrogen SARL, Cergy-Pontoise, France) by nick translation (Abbott Molecular, Des Plaines, IL) and used at a final concentration of 10 ng/l. The telomeric probe (3'biotinylated 24-mer composed of three TTAGGG repeats

with LNA modifications (kindly prepared by Christophe Escudé, MNHN-UMR 7196 CNRS-INSERM) was used at a final concentration of 0.3 M.

Chromosome preparations were denatured at 75 °C for 5 min, hybridized during 48 h at 37 °C, in a denaturation/hybridization system (ThermoBrite™, StatSpin, Abbott Laboratories, Illinois) and washed at 37 °C for 5 min in 2× SSC, pH 7. Hybridized probes were revealed in green by indirect detection with goat anti-biotin antibodies (10 mg/ml, Vector Laboratories, Burlingame) followed by FITC-conjugated anti-goat antibodies (5 mg/ml, Paris, France). Chromosomes were counterstained in orange with propidium iodide (PI, 0.3 mg/ml). Observations were performed with an epifluorescent microscope (DMRB, Leica Microsystem, Germany), and images were captured using a cooled CCD camera (ProgRes MS cool, Jenoptik, Germany) and treated by a capture software (Isis, Metasystems, Altusheim, Germany). Chromosomes were identified using a computer-generated reverse PI banding. All human painting probes were hybridized on two

specimens with karyotype I (see below), and only some paintings were hybridized on specimens with karyotypes II, III, and IV for characterizing the interspecimen rearrangements (Fig. 2). 28S and telomeric probes were hybridized on one or two specimens with each karyotype.

Results

Brief karyotype description

Four different karyotypes could be established among the 21 specimens studied, with chromosome numbers ranging from 38 to 42.

Karyotype I (Fig. 2). It was observed in three specimens from the Hinboum district and one from the

western part of the Thakhek district (Fig. 1). Two specimens belong to the mitochondrial DNA (mtDNA) group B, one to the mtDNA group E, and one to the mtDNA group A of Nicolas et al. (2012). Their karyotype is composed of 42 chromosomes, including 4 pairs of very large sub-metacentric, 1 pair of small metacentric, and 15 pairs of acrocentric autosomes. The X is sub-metacentric, and the Y is a very small acrocentric. All human (HSA) chromosome painting probes were successfully hybridized, which allowed us to propose homologies for almost all chromosome fragments. Some examples are shown in Fig. 3. The four large sub-metacentrics appear to be formed by multiple fragments, which correspond to up to eight human chromosomes for pair no. 2. In Fig. 4, the chromosomes of two half RBG and GBG karyotypes are paired for indicating the correspondences between the two bandings. The

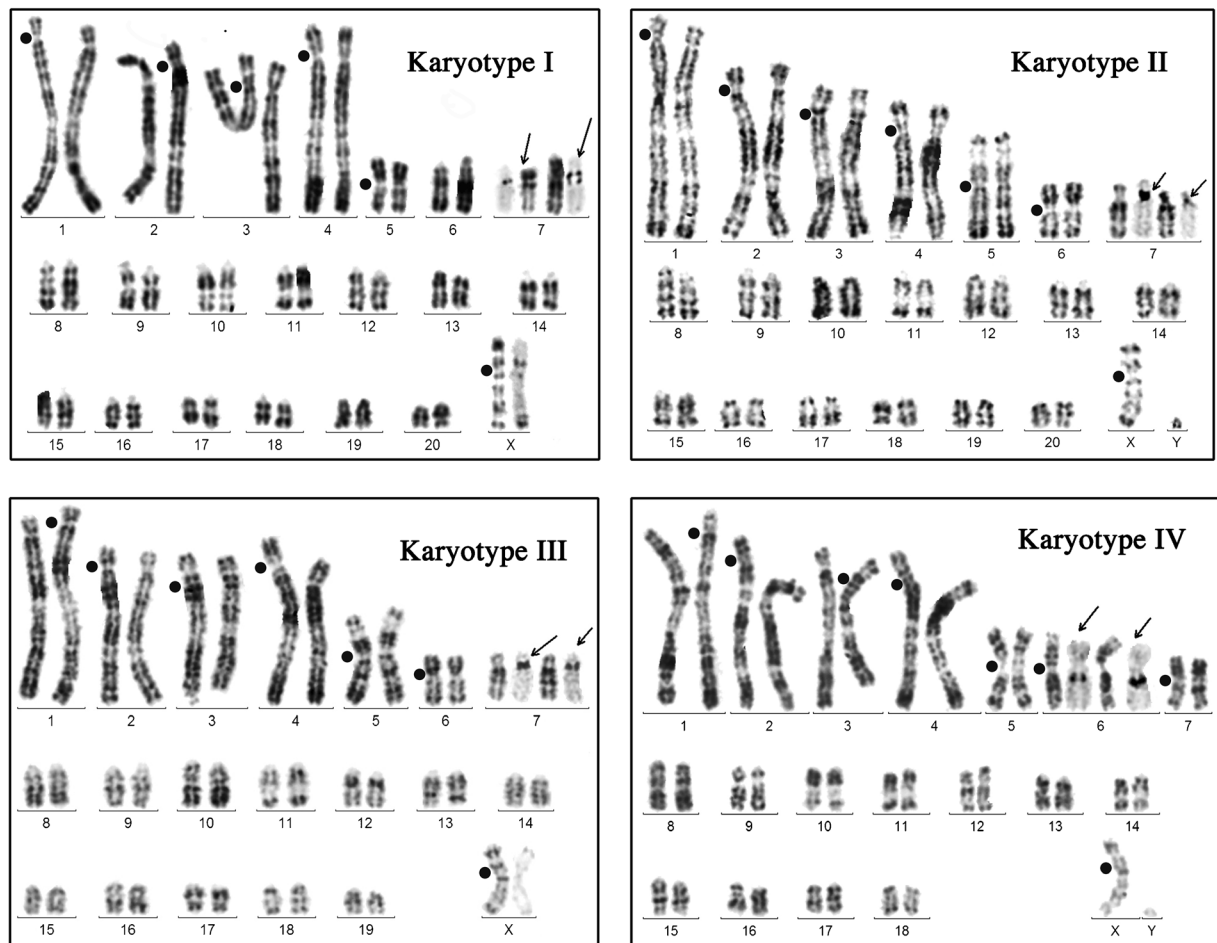

Fig. 2 R-banded (RBG) karyotypes I to IV. Silver staining of the NOR carrier chromosomes is added (*arrows*). FISH with a 28S probe gave similar results (not shown). Notice the NOR

duplication in karyotype I and the pericentric inversion of chromosome 7 in karyotype II. *Dark circles* indicate centromere locations in non-acrocentric chromosomes

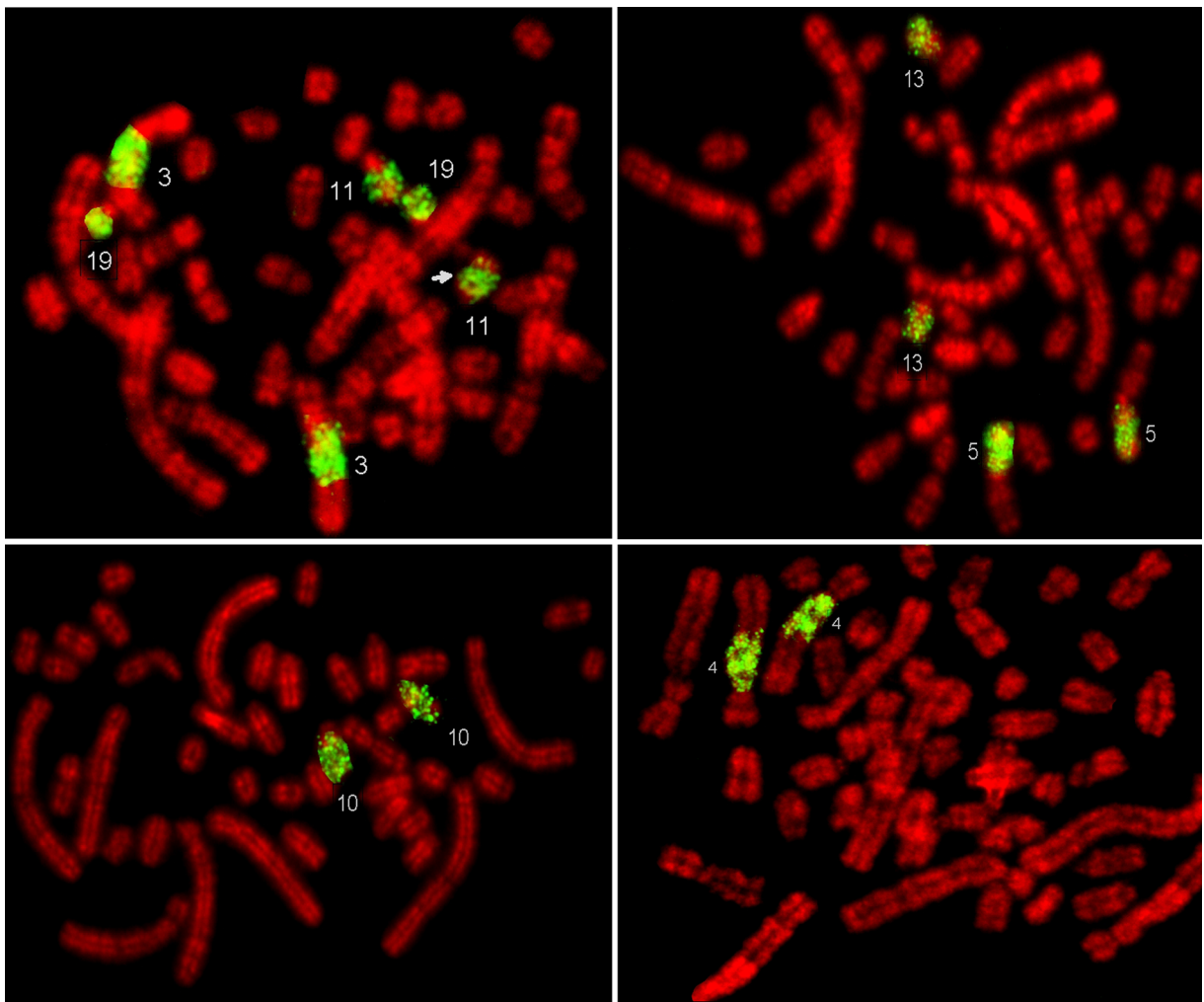

Fig. 3 Examples of chromosome painting with human (HSA) probes. **a** HSA3 on chromosomes 3, 11, and 19 of karyotype II; **b** HSA9 on chromosomes 5 and 13 of karyotype II; **c** HSA13 on chromosome 10 of karyotype I; and **d** HSA17 on chromosome 4 of karyotype II

correspondences with human chromosome paintings are indicated on the left of the G-banded chromosomes, and a dark circle indicates the centromeres of the six sub-metacentrics. Acrocentric look larger after G- versus R-banding because late replicating pericentric heterochromatin is not stained by RBG banding. The active NOR was located by silver staining on the proximal part of the long arm of chromosome 7 (Fig. 2). It is the unique 28S DNA location detected by FISH (not shown), but there is a heterozygosity for a tandem duplication of the NOR. After C-banding, all centromere regions are about equally banded.

Karyotype II (Fig. 2). It was observed in seven specimens, captured in the Thakhek district. All belong to the mtDNA group A. This karyotype is composed of 42

chromosomes, including 4 pairs of very large sub-metacentric, 1 large and 1 small pair of metacentric, and 14 pairs of acrocentric autosomes. The NOR/28S is also located on chromosome 7, but one of the specimens studied is heterozygote for a pericentric inversion, the NOR being on either the short or the long arm. This may indicate a polymorphism in the population. Karyotype II differs from karyotype I by several chromosomes, which were identified by both their banding and their painting (Figs. 2 and 7).

1. The distal third of chromosome 3 is not homologous to HSA20-12-22, as in karyotype I, but to HSA1.
2. The fragment HSA20-12-22 forms an acrocentric (no. 10).

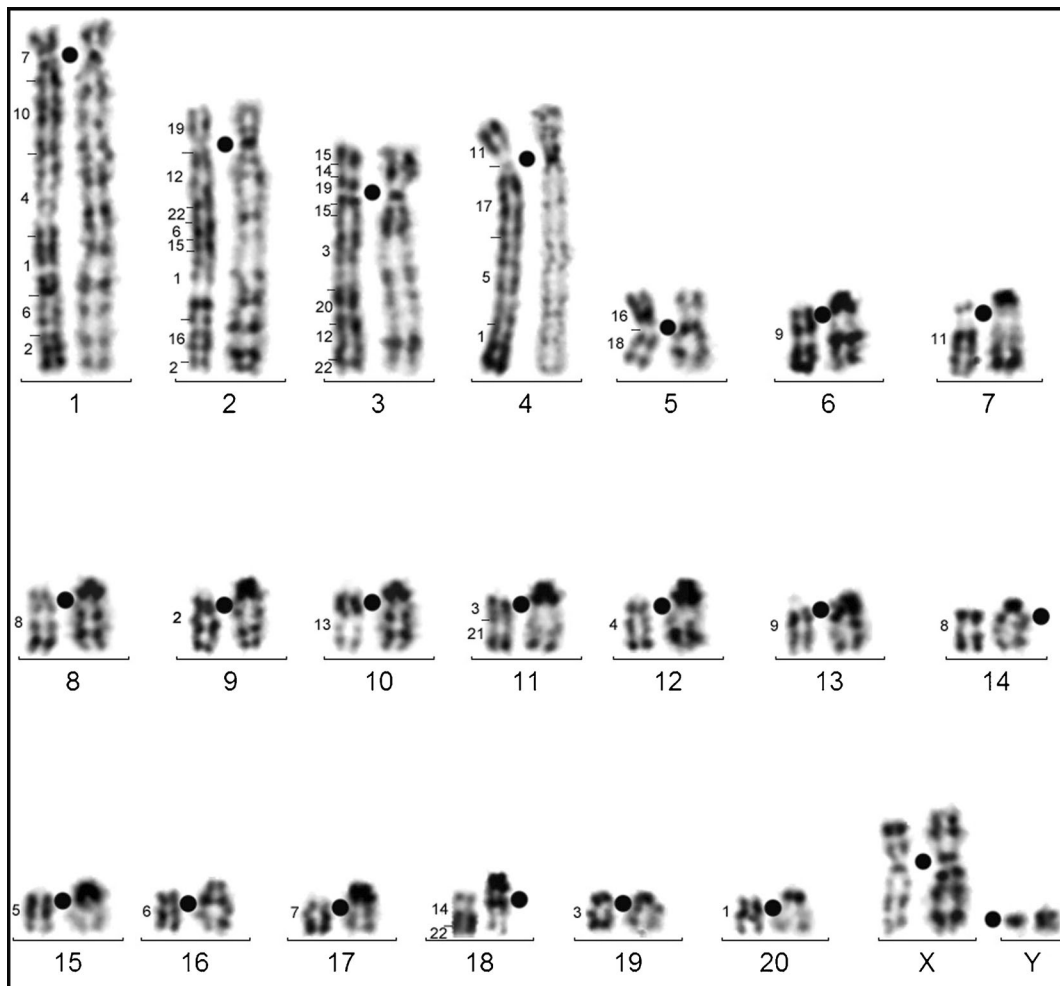

Fig. 4 Paired chromosomes of half R-banded (*left*) and G-banded (*right*) karyotypes. Numbers on the left side of R-banded chromosomes indicate homologies with human chromosomes, identified with chromosome painting. Dark circles indicate centromere locations

3. Chromosome 4 is shorter: It does not comprise the fragment homologous to HSA1.
4. Chromosome 5 is a large metacentric, formed by chromosomes 6 and 10 of karyotype I, homologous to HSA9 and HSA13, respectively.

The obtainment of a nice C-banding was fairly difficult in the six specimens studied. A reasonable C-banding could be obtained at the centromere regions of all the sub-metacentrics, but on acrocentric, it was either faint or absent (Fig. 5a). The six specimens gave the same results.

Karyotype III (Fig. 2). It was observed in six specimens from the Mahaxai district and one from the Thakhek district. All belong to the mtDNA group D. Their karyotype, very close to karyotype I, is composed

of 40 chromosomes. It only differs by the presence of a metacentric (no. 5), formed by the homologs of HSA9 and HSA13. This metacentric is identical to chromosome 5 of karyotype II. The C-banding was comparable to that of karyotype I with all centromere regions similarly banded (Fig. 5b).

Karyotype IV (Fig. 2). It was observed in three specimens from the Hinboum district. All belong to the mtDNA group F. Their karyotype is composed of 38 chromosomes. The large sub-metacentrics 3 and 4 are similar to those of karyotypes I and III and chromosomes 8 and 10, homologous to HSA9 and HSA13, and are acrocentric, as in karyotype I. The reduced number of chromosomes is due to the presence of two sub-metacentrics (chromosomes 5 and 6) formed by the Robertsonian translocation of four acrocentrics present

Fig. 5 C-banded metaphases from specimens with karyotype II (a) and III (b). Notice the poor C-banding of many acrocentrics in a and the intense and homogenous C-banding in b

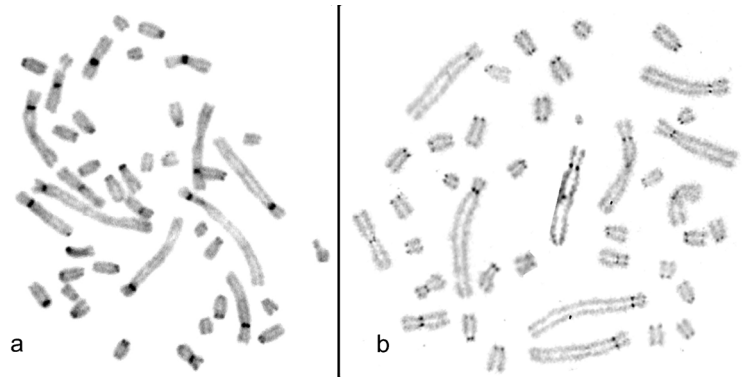

in the three other karyotypes (homologous to HSA8 and 14-22 and HSA6 and 11 for chromosomes 5 and 6, respectively). The C-banding was similar to that of specimens with karyotypes I and III.

Interstitial telomeric sequences

As it could be expected after the reconstruction of the multiple fusions of ancestral chromosomes forming the four largest chromosomes, telomeric sequences are present in interstitial positions (Fig. 6). The positions of many interstitial telomeric sequences (ITS) seem to be compatible with the fusion points of ancient rearrangements, but some are located in chromosome fragments which were not involved in rearrangements, as the homolog to HSA13, which forms the short arm of chromosome 5 in karyotype II. The intensity of FISH signals at terminal positions is not at random, with one large and one small signal per chromosome. On acrocentrics of karyotype II, the largest FISH signals are always located

on the long arms, whereas on the short arms, signals are limited to a single small dot at the telomere of each chromatid (Fig. 6a). At contrast, in karyotypes I, III, and IV, large and intense FISH signals are present on the acrocentric short arms (Fig. 6b). We conclude that telomeric sequences were similarly amplified in specimens with karyotypes I, III, and IV.

Karyotype comparisons

The karyotype comparisons were performed using chromosome banding, which allowed us to identify the chromosomes differing from specimen to specimen. The 22 autosomal human painting probes were hybridized and localized on metaphases from specimens with karyotype I. Then, the painting probes for all the chromosomes, which looked different in other karyotypes, were hybridized on metaphases with karyotypes II, III, and IV. The result is shown by numbers indicating the homologies with human chromosomes on the right or

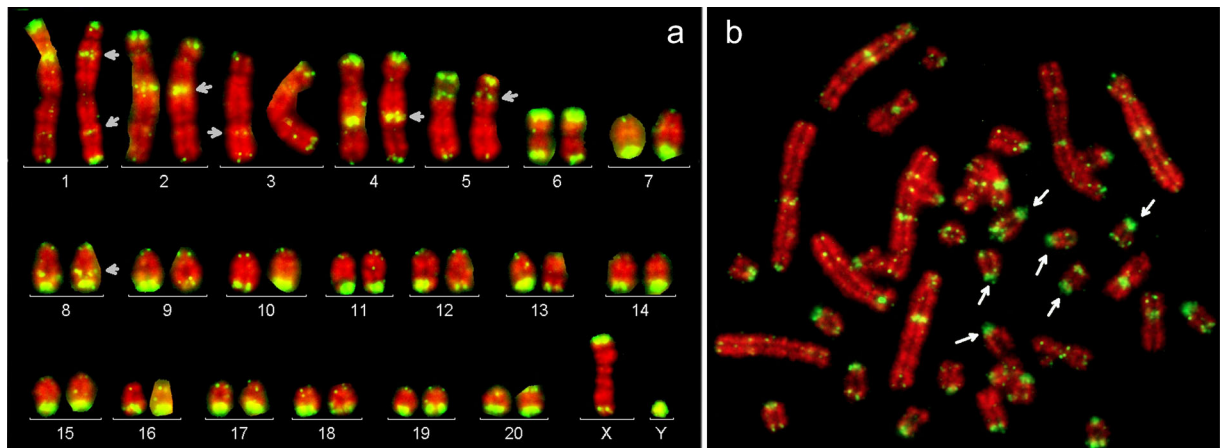

Fig. 6 FISH with telomeric probes. **a** Karyotype II. Arrows point out the most recurrent ITS. Notice the very small signals on acrocentric short arms. **b** Metaphase from a specimen with karyotype IV. Arrows point some of the acrocentrics with an intense signal on their short arm

left side on *Laonastes* chromosomes (Figs. 4 and 7). The 10 chromosome fragments, identified by their homologies with human chromosomes involved in rearrangements, are schematized in Fig. 7. All but two of them (homologous to HSA1 and HSA15-14-19-15-3) occur as a unique chromosome in at least one karyotype. Six of them form one arm of a sub-metacentric pair in one or two karyotypes (HSA9 + HSA13 in karyotypes II and III, and HSA6 + HSA11 and HSA8 + HSA14-22 in karyotype IV). Interestingly, one of the fragments homologous to HSA1 is involved in two different combinations: fusion with the fragment homologous to either HSA11-17-5 in karyotypes I, III, and IV or HSA14-15-19-15-3 in karyotype II. In addition, in karyotypes I, III, and IV, the fragment HSA20-12-22 is syntentic with the

fragment HSA14-15-19-15-3. This makes the difference between karyotype II and others very complex. In the cross product between a specimen with karyotype II and any other, the resulting homobrachial heterozygosity could have two main consequences: (1) a synapsis defect that would stop gametogenesis at meiotic prophase and (2) in case of a correct synapsis, the formation of a large pentavalent, with a high risk of unbalanced chromosome segregation at anaphase I. This should create an efficient genetic barrier, insulating karyotype II. This insulation is supported by C-banding and FISH of telomere repeats, which show similar patterns in karyotypes I, III, and IV but very different in karyotype II. However, the number of specimens studied is too small to formally discard the existence of intra-population polymorphisms.

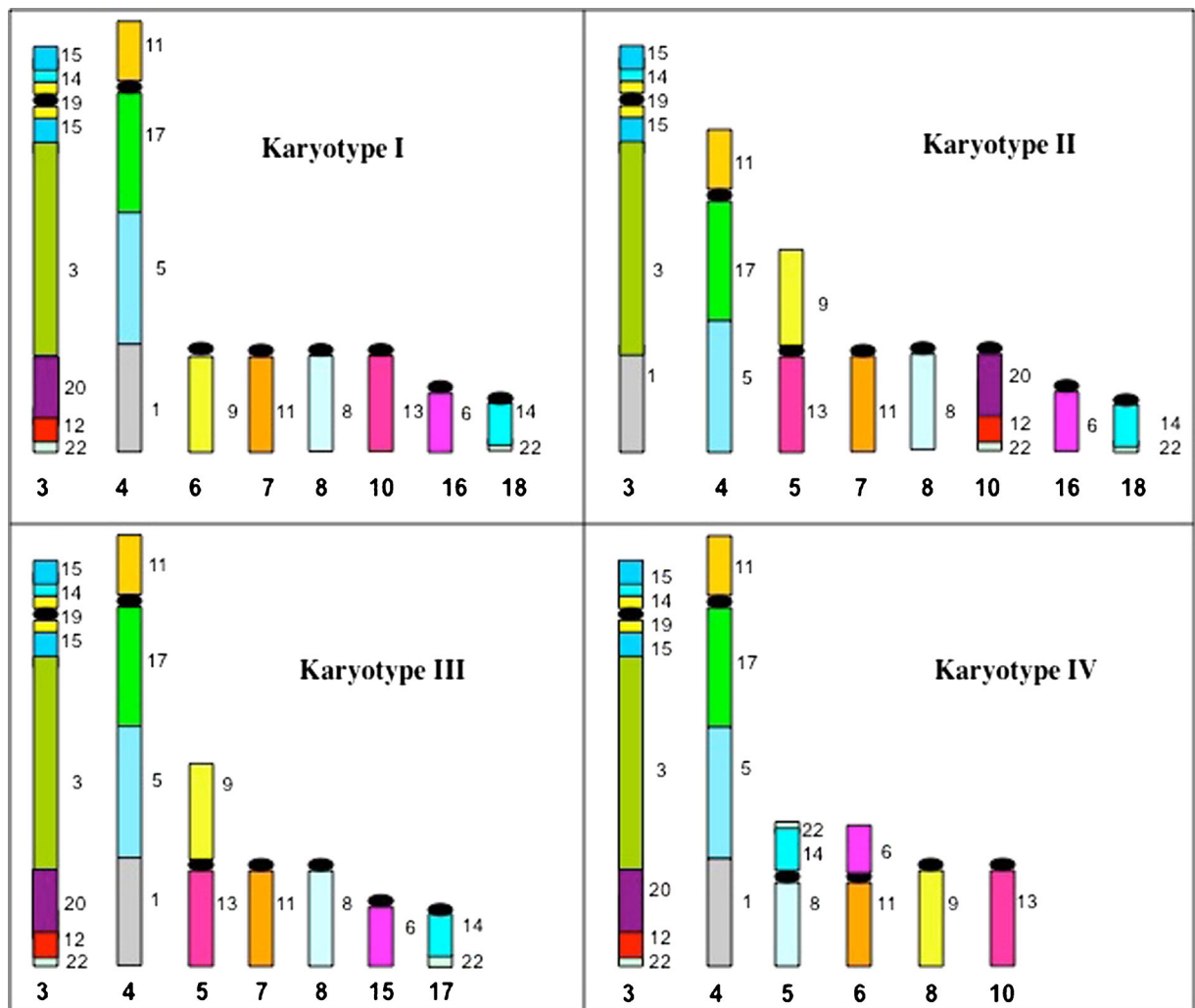

Fig. 7 Scheme indicating by *colored bars* the 10 chromosome fragments involved in rearrangements separating the four karyotypes. Homologies identified by FISH with human chromosomes are shown on the right of each fragment

Comparison with mtDNA groups (Nicolas et al. 2012)

The geographic origin of the 21 karyotyped specimens is indicated in Fig. 1. They form four geographically well-defined cytogenetic groups, represented by roman numbers I, II, III, or IV in circles. The different colors of the circles refer to the mtDNA groups (A to F) to which they belong (Nicolas et al. 2012). Cytogenetic and mtDNA groups are generally congruent, with the exception of karyotype I within which three different mtDNA groups are represented: A, B, and E. This suggests that karyotype I appeared before the differentiation of the mitochondrial groups.

Discussion

Reconstruction of the karyotype of *Laonastes* common ancestor and evolution

In addition to that of eutherian mammals (Richard et al. 2003), the presumed ancestral karyotypes of all rodents and various taxonomic groups (families, sub-families, genera) of rodents have been proposed, following chromosome painting studies (Richard et al. 2003; Yang et al. 2006; Stanyon et al. 2004; Romanenko et al. 2006; Graphodatsky et al. 2008; Beklemisheva et al. 2011; Sannier et al. 2011, e.g.). These reconstructions followed the principle of parsimony, which was applied here for reconstructing the ancestral karyotype of the genus *Laonastes*. For instance, the chromosome fragments homologous to HSA1 and HSA20-12-22 being both involved in tandem fusions, but in different combinations, we concluded that they were free in the karyotype of the ancestor and further involved in two different rearrangements. The same reasoning was applied for the various chromosomes which are acrocentric in two or three karyotypes and form one chromosome arm of a sub-metacentric in one or two other karyotypes. We came to the conclusion that the karyotype of the *Laonastes* common ancestor was probably composed of 46 chromosomes, including 4 pairs of large sub-metacentric, 1 pair of small sub-metacentric, and 17 pairs of acrocentric autosomes (Fig. 8). This reconstruction was compared to those published for other rodents. In Table 1, we indicated the adjacent syntenic fragments, identified by their homology with human chromosomes, in the published ancestral karyotypes of eutherian mammals and rodents (Richard et al. 2003; Romanenko et al. 2006;

Graphodatsky et al. 2008; Beklemisheva et al. 2011). The six syntenies proposed for the eutherian ancestor (Table 1) also are found in the reconstructed ancestral karyotypes of Rodentia, Sciuridae, and Glires, but not of Muroidea and *Laonastes*, which conserved only three syntenies. Thus, the ancestral karyotypes of both Muroidea and *Laonastes* seem to be highly derived, but no new synteny has been acquired in common and only two similar ancestral syntenies were conserved.

From the ancestral karyotype of *Laonastes*, two tandem fusions occurred in a common trunk for karyotypes I, III, and IV (Fig. 9). No other rearrangement occurred for karyotype I, and two Robertsonian translocations formed karyotype IV. Another Robertsonian translocation formed karyotype III. Karyotype II does not share the common trunk with others. It derived from the karyotype of the *Laonastes* ancestor by one tandem fusion and one Robertsonian translocation. The tandem fusion strongly separates this karyotype from others, whereas the Robertsonian translocation is shared with karyotype III. Thus, either the same Robertsonian translocation occurred twice independently, by convergence, during a dichotomic evolution, or it occurred only once, before the occurrence of the tandem fusion, during a reticulated evolution (Fig. 9). The interpretation that the Robertsonian translocation is convergent is retained in Fig. 9, although an incomplete lineage sorting, with a population polymorphism for the presence or absence of the Robertsonian translocation, cannot be excluded.

The main characteristic of the various karyotypes of *Laonastes* is the presence of very large chromosomes, obviously derived from multiple rearrangements, as demonstrated by the presence of up to eight fragments homologous to human chromosomes on a single chromosome. In these large chromosomes, no additional adjacent syntenies corresponds to those proposed for the ancestors of other rodents such as Glires, Sciuridae, or Muroidea (Romanenko et al. 2006; Graphodatsky et al. 2008; Sannier et al. 2011; Beklemisheva et al. 2011; Richard and Dutrillaux 2012). Interestingly, the size increase of some chromosomes was a tendency yet at work in the evolution of genus *Laonastes*: three of the six rearrangements differentiating the karyotypes of our specimens are tandem fusions increasing the size of pairs 3 and 4. This tendency for an accumulation of the same type of chromosome rearrangements in a given lineage was initially described in insects as the phenomenon of orthoselection (White 1973) and in mammals as orthomutation (Dutrillaux 1979). As shown in other

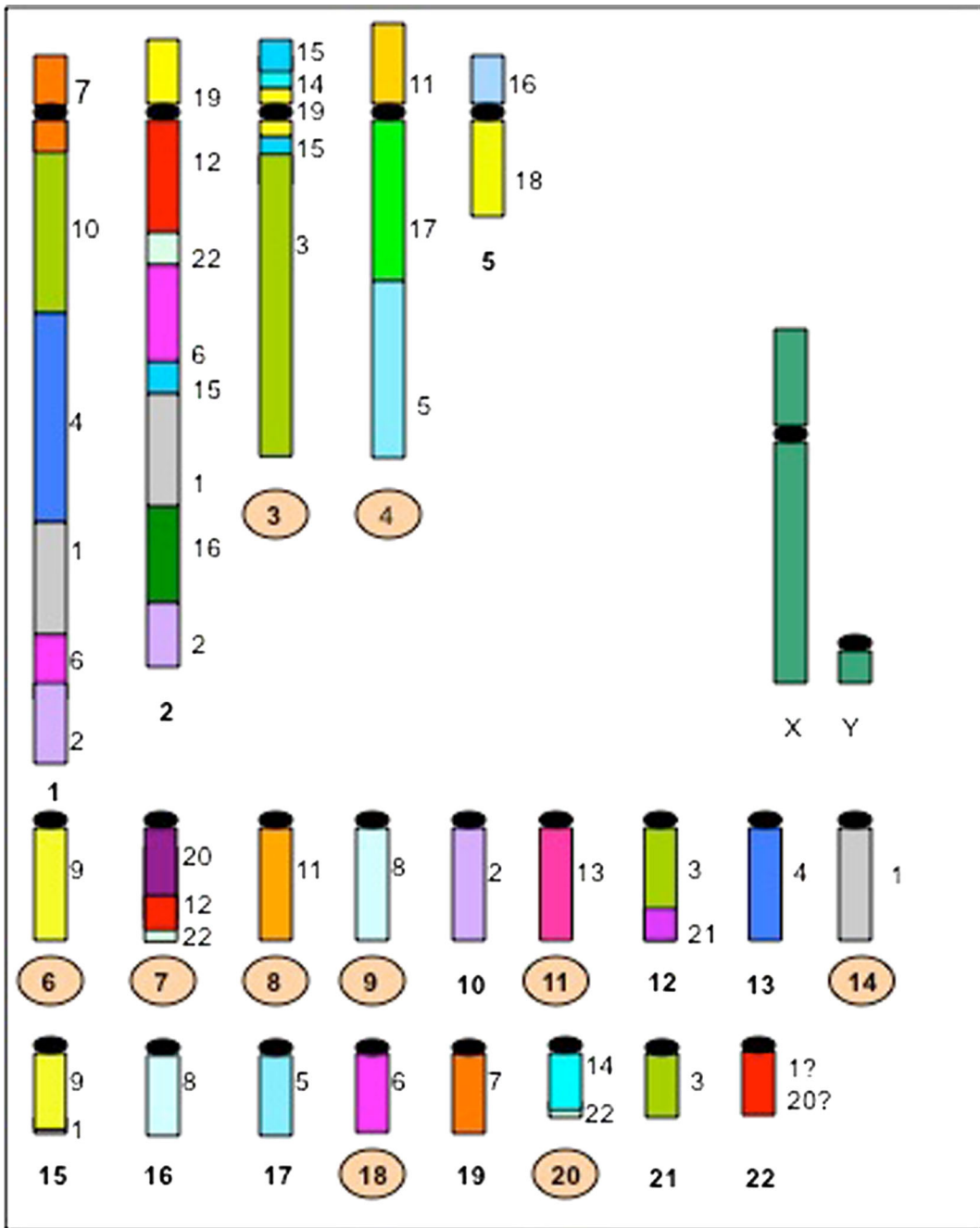

Fig. 8 Presumed ancestral karyotype of the genus *Laonastes*. Homologies with human chromosomes are shown on the right side of chromosomes. Chromosomes involved in rearrangements (see Fig. 5) are indicated by circles at the bottom

species with large chromosomes originated by tandem fusions, such as the Indian muntjac, ITS may be present (Lee et al. 1993). Here, ITS were detected on chromosomes 1–4 of *Laonastes*, with two levels of intensity of the FISH signals (Fig. 6). Their positions are compatible with the presumed fusion points of tandem fusions.

Both the detection of the 28S DNA by FISH and the active NOR by silver staining indicate a unique location, at the proximal region of the long arm of the acrocentric homologous to HSA11. In many species, NORs are involved in frequent rearrangements (breakage, duplications, and translocations), at both the infra-specific and

Table 1 Comparison of the adjacent syntenies (human chromosome nomenclature) proposed for karyotypes of presumed ancestors or described in species

Presumed ancestor	No of adjacent syntenies	Adjacent syntenies											Ref			
		3-21	4-8	7-16	12-22	14-15	16-19	1-10	3-19	9-11	2-15	1-15		3-20	7-10	11-17
Eutherian	7	+	+	+	+	+	+									1
Rodentia	9	+	+	+	+	+	+	+	+							2
Sciuridae	15	+	+	+	+	+	+	+	+	+						3
Glires	9	+	+	+	+	+	+			+						4
Eumuroidea	66	+	+		+						+					5
<i>Laonastes</i>	24	+			+	+						+	+	+	+	6
<i>Cavia porcellus</i>	78	+	+		+	+						+	+	+	+	7

Only syntenies recurrently observed are mentioned. Ref: references 1: Richard et al. (2003), 2 and 3: Graphodatsky et al. (2008), 4: Beklemisheva et al. (2011), 5: Romanenko et al. (2006), 6: this study, and 7: Romanenko et al. (2015)

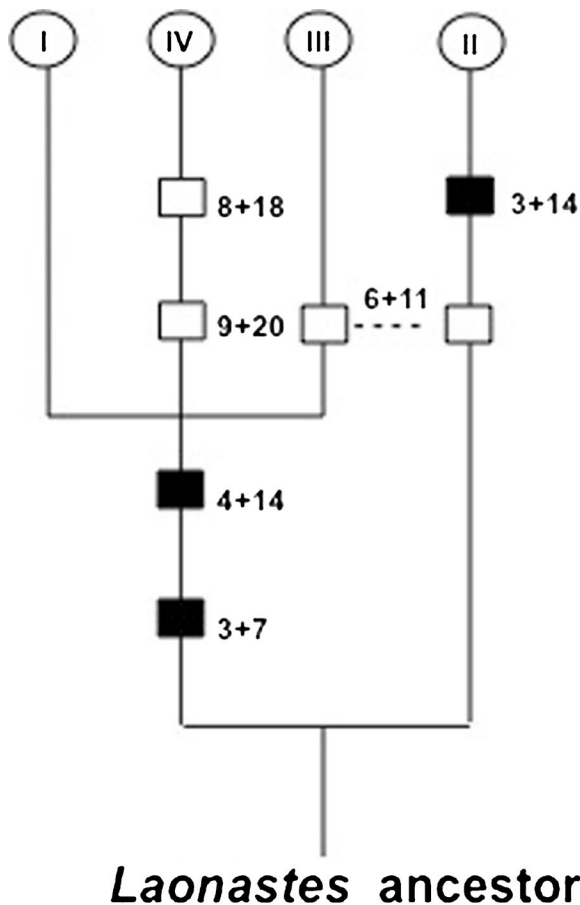

Fig. 9 Most parsimonious phylogenetic relationships between the four karyotypes. Robertsonian translocations (*white squares*), tandem translocations (*dark squares*), same rearrangement acquired in karyotypes II and III (*dotted line*), indicating a possible reticulated evolution. Numbers correspond to chromosomes of the presumed *Laonastes* ancestor (Fig. 8)

inter-specific level. Here, a duplication of the NOR occurred in karyotype I, and the chromosome homologous to HSA11 is involved in a Robertsonian translocation in karyotype IV, but the breakpoint does not involve the NOR (Fig. 2).

Karyotype and systematics

1. Position of *L. aenigmamus* among rodents: *L. aenigmamus* was classified as the only living representative of the Diatomyidae (Dawson et al. 2006). The phylogenetic position of this family is still a matter of debate, but some morphological characters support that it belongs to Hystrichognathi (Flynn 2007). This interpretation is not far from the molecular phylogeny proposed by Huchon et al. (2007), who considered *L. aenigmamus*, and thus Diatomyidae, as the sister group of Hystrichognathi within the Ctenohystrica clade. Thus, a common trunk between *L. aenigmamus* and Hystrichognathi may have existed, which could be confirmed if *L. aenigmamus* shares specific chromosome characters with some species of this infraorder. In the genome of *Cavia porcellus* (Hystrichognathi), 78 syntenies of conserved human autosomal segments were detected (Romanenko et al. 2015). Only four of the six syntenies from the presumed eutherian ancestor (Richard et al. 2003) and none of the three additional syntenies of the presumed rodent ancestor (Graphodatsky et al. 2008) are conserved in *C. porcellus* (Table 1). The authors conclude that the highly derived karyotype of this species explains the loss of the ancestral syntenies. The karyotype of

the presumed ancestor of genus *Laonastes* (Fig. 8) is much less rearranged than that of *C. porcellus*, with only 24 syntenies. It conserved only three of the four syntenies of the eutherian ancestor and none of the rodent ancestor, as *C. porcellus*. In addition, 4 (7-10, 1-15, 3-20, and 11-17) of the 75 new syntenies of *C. porcellus* are also found among the 23 new syntenies of the genus *Laonastes*. These syntenies are found neither in the genomes of the other rodents studied nor in their presumed ancestors (Richard et al. 2003; Romanenko et al. 2006; Graphodatsky et al. 2008). All together, these data suggest that genera *Cavia* and *Laonastes* and thus Hystricognathi and Diatomyidae ancestors shared a number of chromosome rearrangements in a common trunk.

2. *Laonastes*, a mono- or poly-specific genus? In mammals, the relationship between karyotype and species is not univocal. Some species morphologically and geographically well separated share the same karyotype, as most species of baboons and macaques (Cercopithecinae, Primate) (Dutrillaux 1979; Dutrillaux et al. 1982), while different karyotypes may coexist in a single or presumed single species, as here in *L. aenigmamus*. As usual for wild mammals, no breeding data are available, and when the presence of cryptic species is suspected, genetic data are among the rare informative parameters. The number of DNA mutations separating two genomes informs about their genetic distance and eventually the occurrence of a gene flow interruption (Johns and Avise 1998; Hebert 2002). The reconstruction of chromosome rearrangements may provide also predictive arguments about the reproductive fitness of eventual hybrids. In *Laonastes*, sequencing of nuclear and mitochondrial DNA has shown large inter-population differences within a fairly small area corresponding to that of our sampling (Nicolas et al. 2012). The number and distribution of both mitochondrial and nuclear mutations suggest a fairly ancient separation of several populations. The authors concluded to the presence of an exceptional example of micro-endemism, with 8 to 16 evolutionary significant units compatible with the existence of a complex of species or sub-species. Chromosome comparisons indicate the very probable existence of an efficient gametic barrier between karyotype II and others because the same chromosome fragment (homologous to HSA1) is involved in a tandem fusion with the same

chromosome (homologous to HSA11-17-5) in karyotypes I, III, and IV and with another chromosome (homologous to HSA15-14-19-15-3) in karyotype II. In case of crossing between specimens with karyotype II and others, the resulting homobrachial heterozygosity should form a pentavalent during meiotic prophase and drastically impair chromosome segregation, thus the reproduction the first generation descendants, as discussed above. As shown in Fig. 9, specimens with karyotypes I, III, and IV share a common trunk and are further separated by one to three Robertsonian translocations. Such rearrangements, recurrently observed in mammalian populations, particularly in Muridae (Capanna et al. 1976), probably have a mild effect on reproduction: Their frequent presence at the heterozygote status demonstrates that they do not constitute a strong gametic barrier. Thus, the analysis of chromosome rearrangements in *Laonastes* leads to consider that there is a strong reproductive separation between populations with karyotype II and others but not between populations with karyotypes I, II, and IV. These interpretations are supported by the characteristics of heterochromatin and telomeric sequences, revealed by C-banding and FISH, respectively. Within each of the karyotypes I, III, or IV, the sizes of both C-bands and telomere FISH signals on acrocentric chromosomes are similar. Thus, a phenomenon of homogenization of repeated DNA sequences (Schweizer and Loidi 1987), which reflects multiple exchanges between these sequences, has possibly occurred, within each population. Interestingly, the patterns of both C-banding and FISH of telomeric sequences are very similar in karyotypes I, III, and IV. Thus, the homogenization process was possibly common, which suggests the conservation of a gene (or repeated DNA) flow during a long period. The global reduction of C-banded heterochromatin and telomeric FISH signals in karyotype II also suggests the occurrence of a phenomenon of homogenization, but opposite to that of karyotypes I, III, and IV. This constitutes an additional argument in favor of a complete reproductive insulation of the population with karyotype II, but studies on meiosis and inter-population hybridizations are needed for a definitive conclusion. The comparison of our data with those of Nicolas et al. (2012) does not raise major discrepancies: Karyotypes I, II, III, and IV

correspond to the mitochondrial groups E, A, D, and F, respectively, but three different mitochondrial groups (A, B, and E) share the same karyotype (I). The relationship between the molecular data and the geographical distribution of *Laonastes* and the inferred history of the karsts of the Khammuan region have been extensively discussed by Nicolas et al. (2012). As these authors suggested it for explaining the distribution of mitochondrial and nuclear haplotypes, we conclude that chromosome diversification is ancient and probably occurred before the complete fragmentation of an ancestral panmictic population, i.e., the fragmentation of the calcic block into the limestone outcrops visible today. In conclusion, this cytogenetic analysis of *L. aenigmamus* provides a new example of chromosomal evolution by multiple tandem fusions. Some of these fusions create a strong gametic barrier, which constitutes convincing arguments for proposing that *Laonastes* is not a mono-specific genus, but more studies are needed to reconstruct the complex evolution of this genus, in relation with biogeography.

Compliance with ethical standards

Ethical standards Since November 12, 2008, the conservation of *L. aenigmamus* is regulated in Lao PDR. This species was listed as « Endangered » on the IUCN Red List in January 12, 2009. To perform this study, we obtained an authorization (no. 1183 June 09, 2008) from the Lao Government. In December 2008, March 2009, and November 2009, 2010, and 2011, five sampling field trips took place in the Khammuan Province in collaboration with the Lao National Agriculture and Forestry Research Institute (NAFRI). The Khammuan Province Agriculture and Forestry Office (PAFO) validated our field collection schedule, and an officer escorted us. Almost all the specimens used for this study were dead animals, captured by traditional hunters. For the few animals captured by us, all institutional and national guidelines for the care and use of laboratory animals were followed, in agreement with the American Society of Mammalogists (Sikes and Gannon 2011).

Conflict of interest All authors declare that they have no conflict of interest.

References

- Beklemisheva VR, Romanenko SA, Biltueva LS et al (2011) Reconstruction of karyotype evolution in core Glires. I. The genome homology revealed by comparative chromosome painting. *Chromosom Res* 19:549–565
- Capanna E, Gropp A, Winkring H, Noack, Civitelli MV (1976) Robertsonian metacentrics in the mouse. *Chromosoma* 58: 341–353
- Dawson MR, Marivaux L, Li CK, Beard KC, Metais G (2006) *Laonastes* and the “Lazarus effect” in recent mammals. *Science* 311:1456–1458
- Dutrillaux B (1979) Chromosomal evolution in primates: tentative phylogeny from *Microcebus murinus* (Prosimian) to man. *Hum Genet* 48:251–314
- Dutrillaux B, Couturier J (1981) La partique de l’analyse chromosomique. Ed Masson Paris
- Dutrillaux B, Couturier J, Muleris M, Lombard M, Chauvier G (1982) Chromosomal phylogeny of forty-two species or subspecies of Cercopithecoidea (Primates Catarrhini). *Ann Genet* 25:96–109
- Flynn LJ (2007) Origin and evolution of the diatomyidae, with clues to paleoecology from the fossil record. *Bull Carnegie Mus Nat Hist* 39:173–181
- Gerbault-Seureau M, Bonnet-Garnier A, Richard F, Dutrillaux B (2004) Chromosome painting comparison of *Leontopithecus chrysomelas* (Callitrichine, Platyrrhini) with man and its phylogenetic position. *Chromosom Res* 12:691–701
- Graphodatsky AS, Yang F, Dobigny G et al (2008) Tracking genome organization in rodents by Zoo-FISH. *Chromosom Res* 16:261–274
- Hebert PDN (2002) Biological identifications through DNA barcodes. *Proc Royal Soc Ser B* 270:313–321
- Huchon D, Chevret P, Jordan U et al (2007) Multiple molecular evidence for a living mammalian fossil. *Proc Natl Acad Sci U S A* 104:7495–7499
- Jenkins PD, Kilpatrick CW, Robinson MF, Timmins RJ (2005) Morphological and molecular investigations of a new family, genus and species of rodent (Mammalia: Rodentia: Hystricognatha) from Lao PDR. *Syst Biodivers* 2:419–454
- Johns GC, Avise JC (1998) A comparative summary of genetic distances in the vertebrates from the mitochondrial cytochromes *b* gene. *Mol Biol Evol* 14:1481–1490
- Lee C, Sasi R, Lin CC (1993) Interstitial localization of telomeric DNA sequences in the Indian muntjac chromosomes: further evidence for tandem fusions in the karyotypic evolution of the Asian muntjacs. *Cytogenet Cell Genet* 63:156–159
- Nicolas V, Herbretreau V, Couloux A, Keovichit K, Douangboupas B, Hugot JP (2012) A remarkable case of micro-endemism in *Laonastes aenigmamus* (Diatomyidae, Rodentia) revealed by nuclear and mitochondrial DNA sequence data. *PLoS ONE* 7(11):e48145. doi:10.1371/journal.pone.0048145
- Popescu P, Hayes H, Dutrillaux B (1998) Techniques de cytogénétique animale. Ed INRA Editions, Paris
- Richard F, Dutrillaux B (2012) Low, complex and probably reticulated chromosome evolution of Sciuromorpha (Rodentia) and Lagomorpha. *Cytogenet Genome Res* 137:218–232
- Richard F, Lombard M, Dutrillaux B (2003) Reconstruction of the ancestral karyotype of eutherian mammals. *Chromosom Res* 11:605–618
- Romanenko SA, Perelman PL, Serdukova NA et al (2006) Reciprocal chromosome painting between three laboratory rodent species. *Mamm Genome* 17:1183–1192
- Romanenko S, Perelman PL, Trifonov VA et al (2015) A first generation comparative chromosome map between Guinea pig (*Cavia porcellus*) and humans. *PLoS One*. doi:10.1371/journal.pone.0127937

- Sannier J, Gerbault-Seureau M, Dutrillaux B, Richard F (2011) Conserved although very different karyotypes in Gliridae and Sciuridae and their contribution to chromosomal signatures in Glires. *Cytogenet Genome Res* 134:51–63
- Schweizer D, Loidi J (1987) A model for heterochromatin dispersion and the evolution of C-band patterns. *Chromosom Today* 9:61–74
- Sikes RS, Gannon WL (2011) Guidelines of the American Society of Mammalogists for the use of wild mammals in research. *J Mammal* 92:235–253
- Stanyon R, Yang F, Moreschalchi AM, Galleni L (2004) Chromosome painting in the long-tailed field mouse provides insights into the ancestral murid karyotype. *Cytogenet Genome Res* 105:406–411
- White MJD (1973) *Animal cytology and evolution*, 3rd edn. University Press, Cambridge
- Yang F, Graphodatsky AS, Li T et al (2006) Comparative genome maps of the pangolin, sloth, anteater and human revealed by cross-species chromosome painting: further insight into the ancestral karyotype and genome evolution of eutherian mammals. *Chromosom Res* 14:283–296